





Safgard

170 Series Low Water Cut-Off

120 VAC Operating Voltage

-  Heavy-duty electro-mechanical design for long life.
-  Automatically shuts off burner in a low water condition to prevent boiler damage.
-  Low maintenance. No moving parts to wear stick or hang up, as in float devices.
-  Rugged construction. Designed for the heating professional.



WARNING: To prevent electrical shock or equipment damage, power must be off during installation or servicing of the control. To prevent serious burns, the boiler should be thoroughly cooled before installing or servicing control. Only qualified personnel may install or service the control in accordance with local codes and ordinances. Read instructions completely before proceeding.

1. Where To Install

HOT WATER BOILER INSTALLATIONS

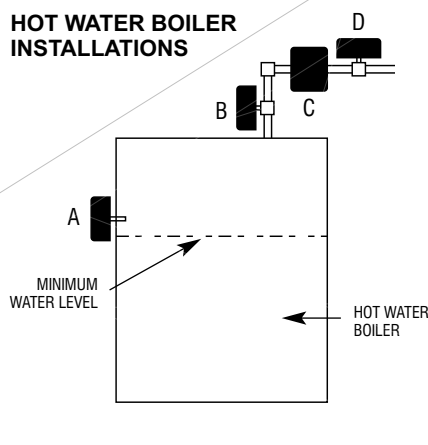

HOT WATER BOILERS: Probe must be installed at or above the minimum safe water level established by the boiler manufacturer. The probe may be installed directly in the boiler if a suitable tapping is available (A), in the riser (B), or in the header (C) or (D).

IMPORTANT: To assure proper drainage, pipe diameter should be no less than 1" on installations in vertical piping and no less than 1 1/4" on installations in horizontal piping.

2. Tee Options

STANDARD REDUCING TEE (SV Models Only)

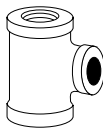

FABRICATED TEE

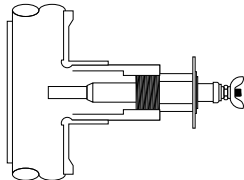

Safgard FOEM-TEE (160psi)

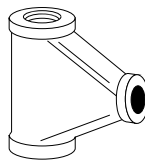

Safgard 1214C-2 TEE (250psi)

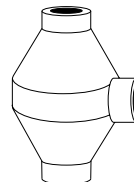

TEE MOUNTING: Model 170SV is equipped with the shorter EL1214-SV probe suitable for mounting in standard reducing tees. For other 170 Series controls, a fabricated tee can be used. Make sure that the tee drains thoroughly when water falls below it and that it conforms to the spacing requirements described in Step 3. Safgard tees are also available to accommodate all probe models (See page 4).

3. Probe Installation

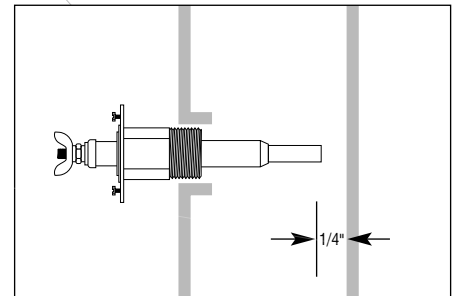

Check to insure 1/4" clearance from the probe to any surface within the boiler or tee. Apply pipe sealing compound to threads.

Note: Use of Teflon tape is not recommended.

4. Control Mounting

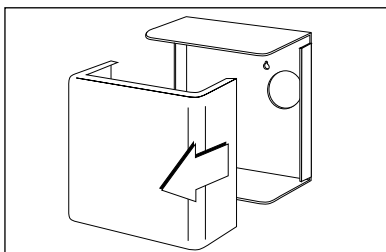

Loosen the two control box cover binding head screws and remove the cover.

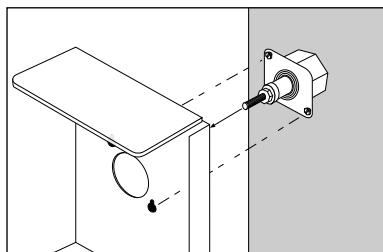

Slide keyhole slots over probe mounting screws and tighten screws (with either a 1/4" hex head driver or flat screwdriver).

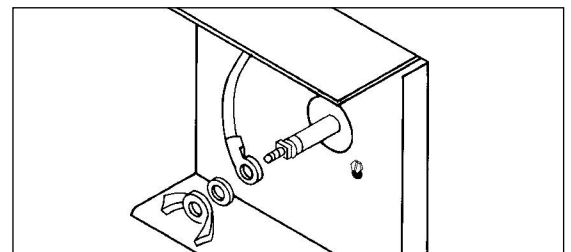

Connect the ring terminal wire lead to the probe terminal stud and secure with the lock washer and wing nut provided. *With the power removed, proceed with installation and wiring according to Method A or B described on next page.*

WIRING METHOD A: SAME POWER SOURCE FOR CONTROL AND BURNER CIRCUIT.

A1

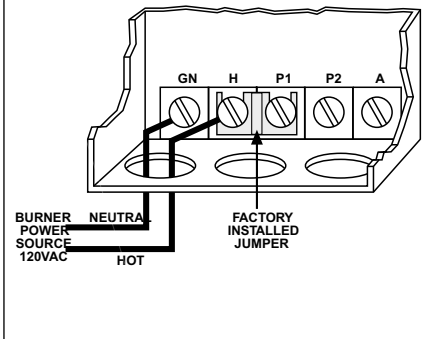

A1 Connect the hot lead of the input voltage (120 VAC, 60 HZ) to terminal H. Connect the neutral lead to terminal GN. 120 VAC, 60 HZ must be supplied to terminals H and GN for internal operation of the control.

A2

Connect terminal GN to burner circuit neutral. Connect terminal P2 to burner circuit in series with other limit controls. Consult boiler manufacturer instructions for proper terminal connections. Control should be wired in series with and before other circuits.

A2

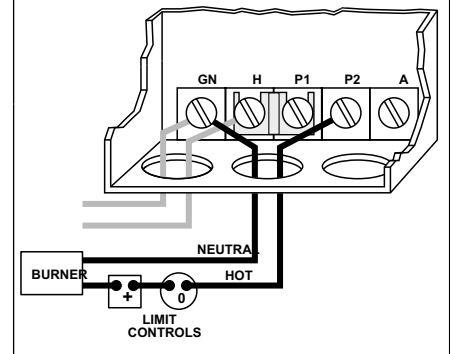

A3

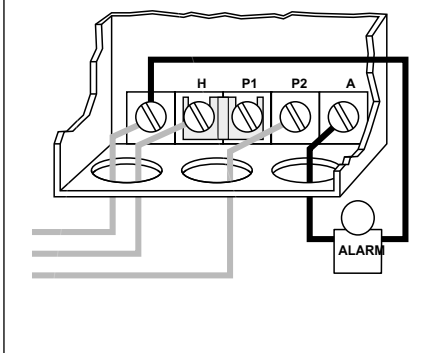

A3 Optional alarm connection. Connect alarm common to terminal GN. Connect alarm hot to terminal A.

Upon completion of wiring, replace control box cover.

WIRING METHOD B: SEPARATE POWER SOURCE FOR CONTROL AND BURNER CIRCUIT.



WARNING: Be sure to remove the jumper between H and P1.

B1

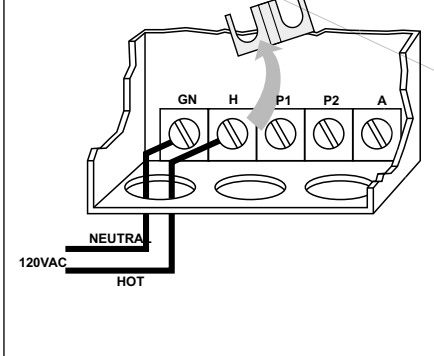

B1 **WARNING!** Remove the jumper between H and P1. Connect the hot lead of the input voltage (120 VAC, 60 HZ) to terminal H. Connect the neutral lead to terminal GN. 120 VAC, 60 HZ must be supplied to terminals H and GN for internal operation of the control.

B2

Connect hot lead from the 24 VAC or 120 VAC burner power source to terminal P2. This terminal supplies power to terminal P1 in normal operating conditions when water is at the probe. Connect neutral to burner circuit. Note: consult boiler manufacturer instructions for proper terminal connections.

B2

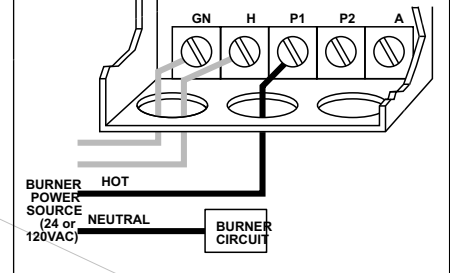

B3

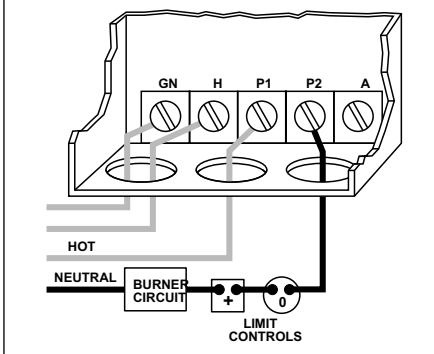

B3 Connect terminal P2 to burner circuit in series with and before other limit controls.

B4

Optional alarm connection. Connect alarm hot to terminal A. Connect alarm common to neutral of the burner power source.

B4

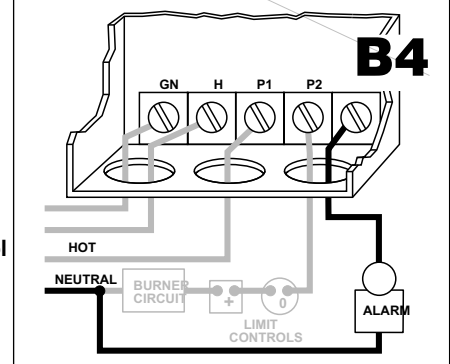

Upon completion of wiring, replace control box cover.

OPERATIONAL TEST PROCEDURE

Important: Do not run boiler unattended until the following procedure is completed.

1. After wiring is complete and prior to raising the water level above the probe set the thermostat to call for heat. The burner should not fire. If the boiler fires with no water at the probe, immediately shut down the boiler and refer to Trouble Shooting Instructions below.
2. Proceed to fill the system with water. When water reaches probe position burner should fire. If burner does not fire with water at the probe refer to Trouble Shooting Instructions below.

MAINTENANCE

When installed on a residential hot water heating system, the probe should be removed and cleaned every five years. When installed on a commercial application, the probe should be removed and cleaned annually. After cleaning the probe, perform the Operational Test Procedure described above.

TROUBLE SHOOTING

IF THE BURNER DOES NOT SHUT DOWN WHEN WATER DROPS BELOW THE PROBE.

1. Remove power immediately and re-check wiring.
2. Remove power and check for adequate clearance from the probe to any surface within the boiler or tee.

IF THE BURNER DOES NOT FIRE.

1. Make sure water is at the probe and probe lead wire is properly secured to probe.
2. Check for proper ground between probe and boiler shell. Excessive use of Teflon tape or sealing compound may insulate the probe from the boiler shell.
3. Check to insure probe is not surrounded by an air pocket. Slowly loosen, but do not remove, the probe with a wrench. Allow any air to escape. When water begins to seep past probe threads, retighten probe.
4. Re-check wiring and test for correct incoming voltage.



Hydrolevel... The Safe Choice for Every Boiler!

Hydrolevel offers a full line of electronic low water cut-offs, water feeders and liquid level controls... everything to give you peace of mind on all your installations. Whether it's hot water or steam, residential or commercial, Hydrolevel makes the right control to complete your installation with safety.

- A. Model 550 Low Water Cut-Off for hot water boilers
- B. Model 170 Low Water Cut-Off for residential hot water boilers
- C. Model CG450 foam-compensating Low Water Cut-Off for steam boilers
- D. Model VXT-24 Automatic Water Feeder
- E. Model 250WC Pump Controller/Low Water Cut-Off.

FITTINGS

Controls equipped with the EL1214-SV Probe can be mounted in standard reducing tees (supplied by others). Safgard manifolds, listed below, can be used with all probe models.



FOEM MANIFOLD



1214C-2 TEE

MODEL	PSI	SIZE
FOEM-1	160	1 1/2" x 1 1/2" x 3/4"NPT
FOEM-2	160	1" x 1" x 3/4"NPT
FOEM-3	160	1 1/4" x 1 1/4" x 3/4"NPT
1214C-2 TEE	250	1" x 1" x 3/4"NPT

PROBE DATA

Test Pressure: 1000 PSI, All Models

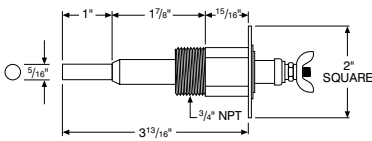

EL1214 – STANDARD MODEL – 3/4" NPT
For 1/2", order Model EL1220

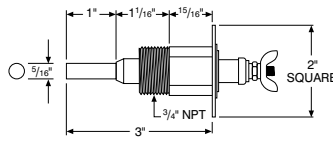

EL1214-SV – 3/4" NPT
For 1/2", order No. EL1220-SV

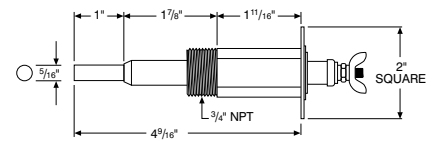

EL1214-P – 3/4" NPT

CAUTION: When installing probe, make sure there is a minimum of 1/4" clearance from probe tip to any surface.

DIMENSIONS

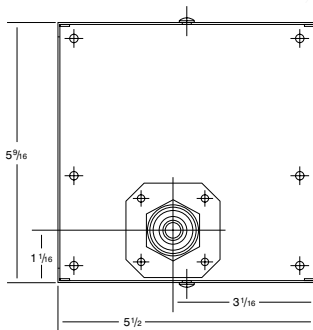

BACK

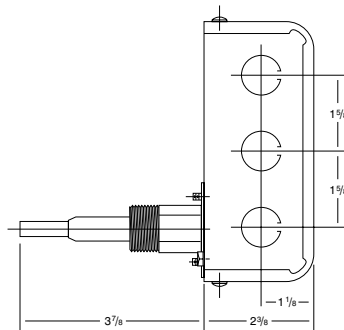

BOTTOM

SPECIFICATIONS

MAXIMUM PRESSURE: 160 PSI
INPUT VOLTAGE: 120 VAC, 60 HZ
SWITCH RATINGS: 5.8 FLA, 34.8 LRA
SWITCH CONTACTS: SPDT
ALARM CIRCUIT: 125 VA @ 120 VAC
 Pilot Duty



LIMITED MANUFACTURER'S WARRANTY

We warrant products manufactured by Hydrolevel Company to be free from defects in material and workmanship for a period of two years from the date of manufacture or one year from the date of installation, whichever occurs first. In the event of any claim under this warranty or otherwise with respect to our products which is made within such period, we will, at our option, repair or replace such products or refund the purchase price paid to us by you for such products. In no event shall Hydrolevel Company

be liable for any other loss or damage, whether direct, indirect, incidental or consequential. This warranty is your EXCLUSIVE remedy and shall be IN PLACE OF any other warranty or guarantee, express or implied, including, without limitation, any warranty of MERCHANTABILITY or fitness for a particular purpose. This warranty may not be assigned or transferred and any unauthorized transfer or assignment thereof shall be void and of no force or effect.

HYDROLEVEL COMPANY